

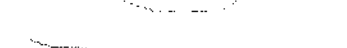



SIERRA RIDGE SUBDIVISION

HISTORIC DRAINAGE PLAN

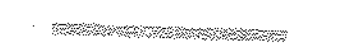

- LEGEND**
-  EXISTING CONTOURS
 -  6800
 -  BASIN DESIGNATOR
BASIN AREA (ACRES)
Q₁₀, Q₅₀, Q₁₀₀ (CFS)
 -  BASINS BOUNDARIES
 -  DIRECTION OF FLOW

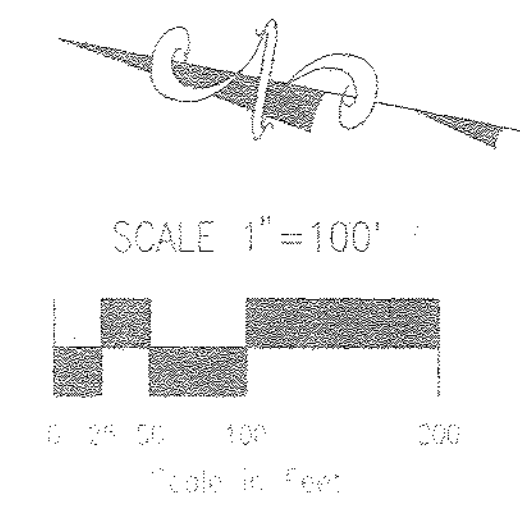

FILE: 94007HDP.DWG 2/16/94



ROCKWELL MINCHOW CONSULTANTS, INC.

ENGINEERING • SURVEYING
2239 STRONG LANE, SUITE #120
COLORADO SPRINGS, CO 80907
(719) 476-2575 • FAX (719) 476-9223

**SIERRA RIDGE SUBDIVISION
HISTORIC DRAINAGE PLAN**

TITLE :	SIERRA RIDGE SUBDIVISION HISTORIC DRAINAGE PLAN				
SCALE :	1"=100'	DRAWN BY :	NC	JOB NO. :	94-007
DATE :	2/16/94	CHECKED BY :	KSR		